

# 8129

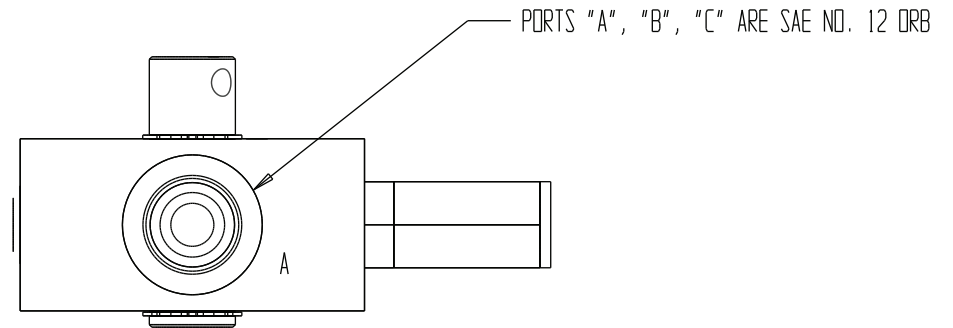
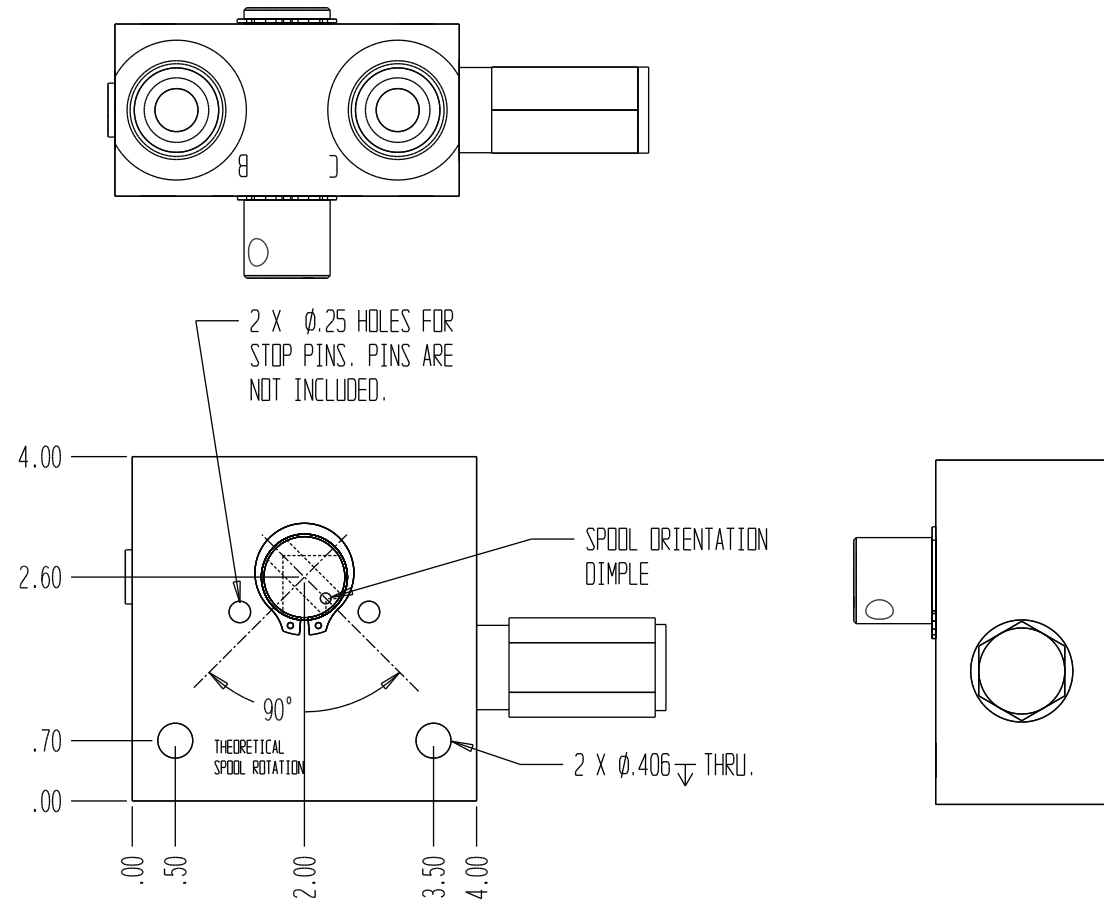
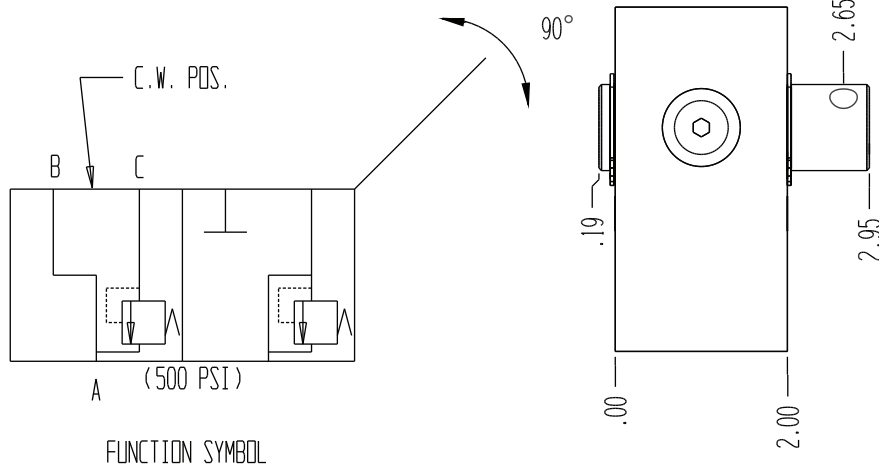

GENERAL SPECIFICATIONS	
PRESSURE	5,000 PSI WORKING
FLOW RATE	20 GPM
MEDIA	PETROLEUM MINERAL BASE SAE 20. OTHER BASES MAY REQUIRE SEAL CHANGES.
SEAL KIT	
LEAKAGE	INTERNAL - 5 CUBIC INCHES/MIN., EXTERNAL - NONE.